

1) WARNING

- a) Read the complete instructions before attempting to install the Rupture Disk and Holder Assembly.
- b) Customer and/or the installer shall be responsible for improper installation and physical damage resulting therefrom, including, but not limited to, damage resulting from leakage, improper torquing, and/or failure to follow installation instructions.
- c) ZOOK standard Terms and Conditions of Sale apply unless otherwise stated in writing by the manufacturer.
- d) Consideration must be given to protecting the attached cable from sharp edges whenever possible.
- e) If equipment is used in applications where it may be subjected to an efficient charging mechanism, such as equipment which may convey fast moving dust laden air then appropriate consideration shall be given to the capacitance of the unearthed metal body in the particular mounting arrangement and risk of charge retention under these conditions.
- f) The equipment shall be regularly cleaned to prevent the build-up of dust deposits.
- g) The A2F gland shall only be used where the temperature is between - 55°C to + 120°C at the point of entry.
- h) The A2F gland is only suitable for fixed installations. Cables must be effectively clamped to prevent pulling or twisting.

2) OPERATING PRINCIPALS

- a) **Switch Actuation** - The Z-ALERT switch is actuated by the introduction of a magnetic actuator into the sensing envelope of the proximity switch. The switch on, or the point at which the actuator causes the switch to operate, is given in mm and is often noted as the Sensing Range of the switch (sr). Once the switch has operated, it will remain in that state until the actuator is withdrawn, the actuator will need to be withdrawn by a greater distance to enable the switch to reset to its unoperated state. The difference between the switch on and switch off points is known as the switch hysteresis.

The Sensing Range - The sensing range referred to for individual switches and magnetic actuators is given in ideal conditions, these distances can vary due to several outside influences. It is first of all recommended that care is taken to ensure that both the switch and the actuator are in line and that their magnetic centres are opposite each other, also that both the switch and actuator are mounted away from ferro magnetic materials which could reduce the sensing range of the switch. If it is not possible to keep away from ferro magnetic materials, euroswitch offers a range of spacers in either Brass or 316 Stainless Steel to help reduce this effect.

3) INSTALLATION INSTRUCTIONS

Installation of Z-ALERT with standard gasket into Holder:

- a) The Switch should be removed from packaging and visually inspected for any damage.
- b) Thread the Retaining nut onto switch (Figure 1).
- c) Thread the switch into the Holder. Care must be taken not to apply any unnecessary twisting motion to the wire where it is connected to the switch. Excessive twisting of the wire WILL cause damage.
- d) The sensor should be threaded into the Outlet until it bottoms out. To allow for correct wire orientation, the switch may be installed until bottomed out and then rotated counter-clockwise no more than 360° to obtain the correct wire orientation. The Switch needs only to be snug. Overtightening may damage switch and holder.
- e) Place Actuator assembly on the Outlet gasket face with the actuator and magnet components oriented so that they are recessed into the Outlet (the Actuator and magnet should be near the disk). See Figure 4.
- f) The Actuator assembly should be oriented so that the switch falls between the alignment forks. The Opposite side should align with the Pre-Assembly holes drilled in the Outlet.
- g) If testing of the sensor is required, it should be wired as per section 4 and its functionality tested by vertically lifting and lowering the Z-Alert Actuator. NOTE: It is critical that the Z-Alert actuator be lifted / lowered entireley. The finger component should not be bent away from the holder wall. For proper operation, the finger portion of the Z-Alert must be flush with the wall. Improper finger alignment may cause false readings.
- h) Tighten the retaining nut until it sits flush with alignment fork (Figure 3). Excessive force should not be used. The retaining nut must only be snug against the fork surface.
- i) Install and tighten Pre-Assembly Bolt, this bolt should also be installed only until snug. Overtightening can damage holder and Z-Alert assembly.
- j) See Section 4 for electrical connection configuration.



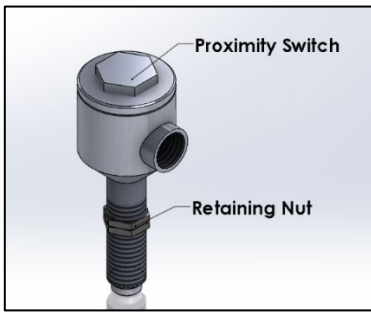

Figure 1 - Z-ALERT Switch

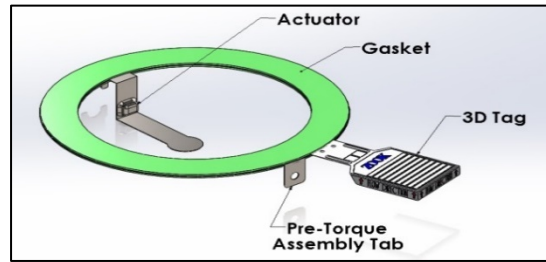

Figure 2 - Z-ALERT Actuator

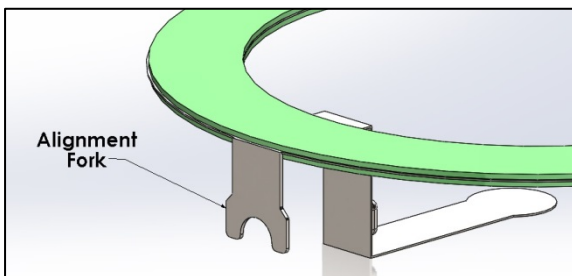

Figure 3 - Z-ALERT Alignment Fork

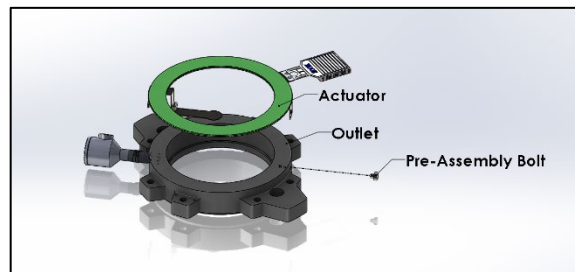



Figure 4 - Z-ALERT Assembly

Installation of Z-ALERT with spiral wound gaskets (SW) into Holder:

- a) The Switch should be removed from packaging and visually inspected for any damage.
- b) Thread the Retaining nut onto switch (Figure 1).
- c) Thread the switch into the Holder. Care must be taken not to apply any unnecessary twisting motion to the wire where it is connected to the switch. Excessive twisting of the wire WILL cause damage.
- d) The switch should be threaded into the Outlet until it bottoms out. To allow for correct wire orientation, the switch may be installed until bottomed out and then rotated counter-clockwise no more than 360° to obtain the correct wire orientation. The Switch needs only to be snug. Overtightening may damage switch and holder.
- e) Place Actuator assembly on the Outlet gasket face with the actuator and magnet components oriented so that they are recessed into the Outlet (the Actuator and magnet should be near the disk)(Figure 4).
- f) Place the atmospheric side spiral wound gasket on the atmospheric side of the Z-Alert (Figure 5).
- g) The Actuator assembly should be oriented so that the switch falls between the alignment forks. The Opposite side should align with the Pre-Assembly holes drilled in the Outlet.
- h) If testing of the sensor is required, it should be wired as per section 4 and its functionality tested by vertically lifting and lowering the Z-Alert Actuator. NOTE: It is critical that the Z-Alert actuator be lifted / lowered entirely. The finger component should not be bent away from the holder wall. For proper operation, the finger portion of the Z-Alert must be flush with the wall. Improper finger alignment may cause false readings. 
- i) Tighten the retaining nut until it sits flush with alignment fork (Figure 3). Excessive force should not be used. The retaining nut must only be snug against the fork surface.
- j) Install and tighten Pre-Assembly Bolt, this bolt should also be installed only until snug. Overtightening can damage holder and Z-Alert assembly.
- k) See Section 4 for electrical connection configuration.

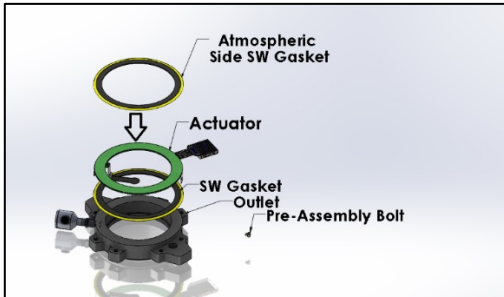
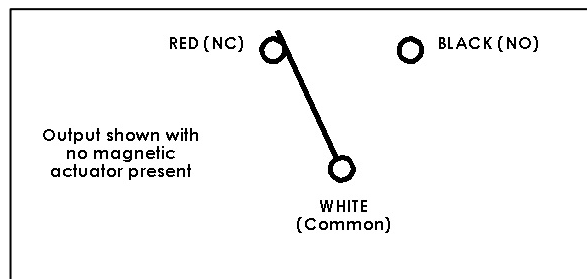

Figure 5 – Z-Alert Spiral Wound Gasket

4) ELECTRICAL CONNECTIONS FOR POLYRAD CABLE WIRING CONFIGURATION

- 1) The diagram below represents the standard wiring method to maintain a Normally Open (NO) or Normally Closed (NC) state.
- 2) Consideration should be given to the use of a latching style relay. In case of an event in the piping system, a latching style relay ensures operator awareness and requires operator intervention to clear.
- 3) Refer to the diagram below for wiring.



Surge Protection

- 1) Surge Protection - Capacitive loads (in extremely long cable runs) and Lamp loads are prone to high in-rush currents which can greatly reduce the life of the switch contacts on closure. The addition of a surge suppression circuit in series with the switch and as close as possible to the switch will alleviate this problem.

For normal signal circuits, the capacitance in the cable can be ignored as several thousands of metres of cable will need to be connected to the switch before damage may be caused. The circuit below is a typical circuit for 230v AC, please consult the factory if in doubt with your full application, we will undertake the calculation for you.

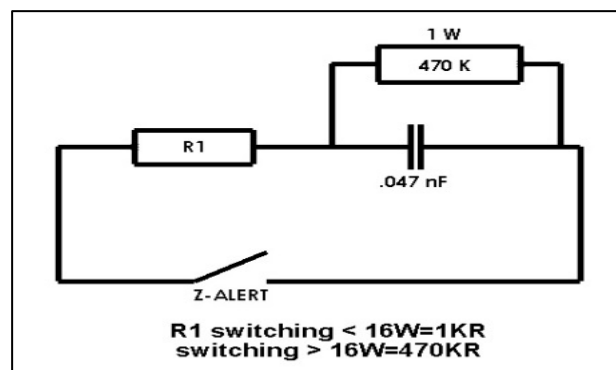

5) TESTING

- a) Testing in hazardous areas must be carried out to site regulations.
- b) Under no circumstances use a "MEGGER" or "BELL TEST SET".
- c) Where permitted use a simple lamp tester as shown or an OHM meter.

